

## Wireless Indoor / Outdoor Thermometer with Digital Clock Model: RAR681

### USER MANUAL

#### INTRODUCTION

Thank you for selecting the Oregon Scientific™ Wireless Indoor / Outdoor Thermometer with Digital Clock (RAR681). The main unit can support up to 3 sensors. To purchase additional sensors, please contact your local retailer.

**NOTE** Please keep this manual handy as you use your new product. It contains practical step-by-step instructions, as well as technical specifications and warnings you should know about.

#### OVERVIEW

##### FRONT VIEW

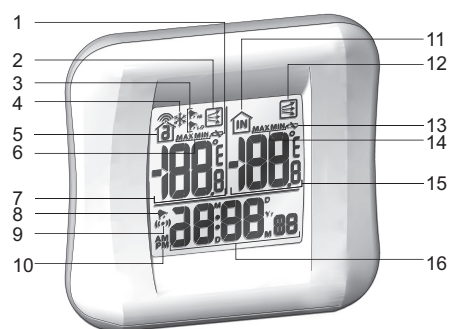

1. Sensor low battery warning
2. Outdoor temperature trend icon
3. Hi / lo alarm is displayed
4. Ice warning is active
5. Channel number and sensor reception status
6. Maximum / minimum outdoor temperature reading
7. Outdoor temperature reading
8. Alarm is set
9. Alarm is displayed
10. 12-hour clock
11. Indoor temperature display icon
12. Indoor temperature trend icon
13. Main unit low battery warning
14. Maximum / minimum indoor temperature reading
15. Indoor temperature reading
16. Time, alarm and date

##### BACK VIEW

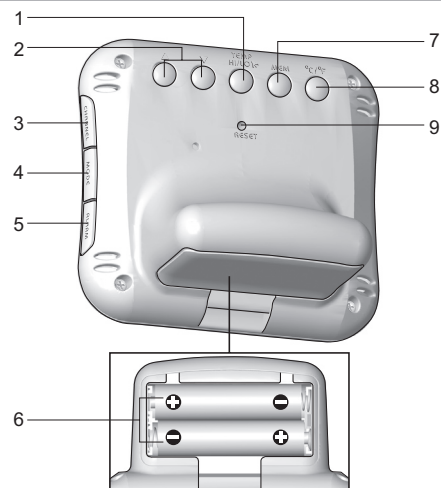

1. **TEMP HI / LO** : Change settings or enable / disable hi or lo temperature alarm for channel 1
2. **▲ / ▼**: Increase / decrease setting; activate / deactivate clock reception signal
3. **CHANNEL**: Switch remote sensor display
4. **MODE**: Change settings / display
5. **ALARM**: View alarm status; set alarm
6. Battery compartment

7. **MEM**: View current, maximum and minimum temperature
8. **°C / °F**: Select temperature unit °C / °F
9. **RESET**: Reset unit to default settings

#### REMOTE SENSOR (THN122N)

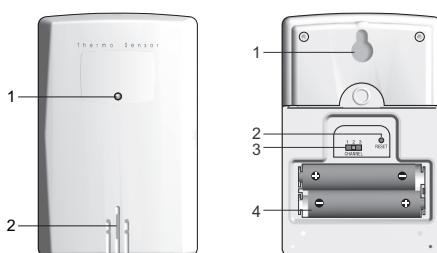

1. LED status indicator: Blinks red during data transmission
2. Ventilation duct
1. Wall mount hole
2. **RESET** hole
3. **CHANNEL** switch
4. Battery compartment

#### GETTING STARTED

##### POWER

Insert batteries before first use, matching the polarity (+ and -).

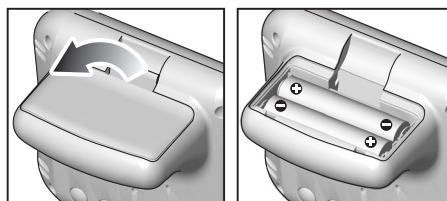

**NOTE** Install batteries in the remote sensor before the main unit. Press **RESET** after each battery change. Do not use rechargeable batteries. We recommend that you use alkaline batteries with this product for longer usage and lithium batteries in temperatures below freezing.

shows when batteries are low.

UNIT	LOCATION
Main	Indoor temperature area
Remote	Outdoor temperature area

#### REMOTE SENSOR

The sensor collects temperature readings approx. every 40 seconds and sends them to the main unit. The main unit can collect data from up to 3 sensors.

##### To set up the sensor:

1. Remove the screws from the battery door.
2. Insert the batteries, matching the polarity (+ / -).

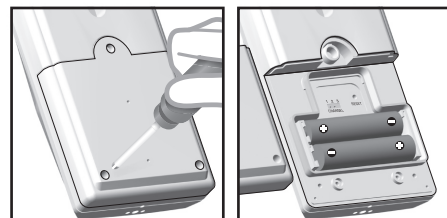

3. Select a channel. Make sure you use a different channel for each sensor.
4. Place the sensor near the main unit. Press **RESET** on the sensor.
5. Simultaneously press **CHANNEL** and **MEM** on the main unit to initiate signal sending between the sensor and main unit.
6. Close the battery door and secure the screws.
7. Place the sensor in the desired location using the table stand or wall mount.

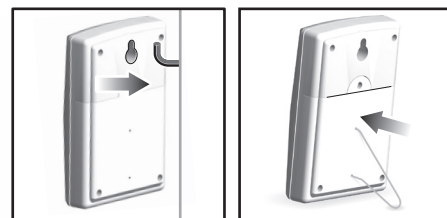

#### For best results:

- Place the sensor out of direct sunlight and moisture.
- Do not place the sensor more than 30 meters (100 feet) from the main (indoor) unit.
- Position the sensor so that it faces the main (indoor) unit, minimizing obstructions such as doors, walls, and furniture.
- Place the sensor in a location with a clear view to the sky, away from metallic or electronic objects.
- Position the sensor close to the main unit during cold winter months as below-freezing temperatures may affect battery performance and signal transmission.

The transmission range may vary depending on many factors. You may need to experiment with various locations to get the best results.

Standard Alkaline batteries contain significant amounts of water. Because of this they will freeze in low temperatures of approximately -12°C (10°F). Disposable Lithium batteries have a much lower threshold for temperature with an estimated freezing range of below -40°C (-40°F).

Wireless ranges can be impacted by a variety of factors such as extremely cold temperatures. Extreme cold may temporarily reduce the effective range between the sensor and the base station. If the unit's performance fails due to low temperature, the unit will resume proper functioning as the temperature rises to within the normal temperature range (i.e. no permanent damage will occur to the unit due to low temperatures).

#### SENSOR DATA TRANSMISSION

Data is sent from the sensor(s) every 40 seconds. The reception icon in the outdoor temperature area shows the status.

ICON	DESCRIPTION
	Main unit is searching for the sensor(s)
	A channel has been found
	Sensor 1 is sending data
	The sensor cannot be found. Search for the sensor or check batteries

#### To search for a sensor:

Simultaneously, press and hold **MEM** and **CHANNEL** for 2 seconds.

**NOTE** If the sensor is still not found, check the batteries, obstructions, and remote unit location.

#### CLOCK

##### To set the clock:

1. Press and hold **MODE** for 2 seconds.
2. Press **▲** and **▼** to change the settings.
3. Press **MODE** to confirm.
4. The setting sequence is: 12 / 24 hour format, hour, minute, year, date / month format, month, date, and display language.

**NOTE** The language options are (E) English, (F) French, (D) German, (I) Italian and (S) Spanish.

##### To switch the clock display:

Press **MODE** to toggle between:

- Clock with seconds
- Clock with day
- Calendar

#### ALARM

##### To set the alarm:

1. Press **ALARM** to view the alarm. will show on the display.
2. Press and hold **ALARM** for 2 seconds.
3. Press **▲** or **▼** to change the hour / minute settings.
4. Press **ALARM** to confirm.

##### To activate or deactivate the alarm:



Press **ALARM** when in the alarm display. appears when the alarm is set.

**To silence the alarm and reset it for the next day:**  
Press **ALARM**.

## TEMPERATURE

**To toggle the temperature unit:**  
Press °C / °F.

**To view outdoor sensor temperature readings:**  
Press CHANNEL.

-  shows which remote sensor's data you are viewing.
-  is permanently displayed in the indoor temperature area.

**To auto-scan between sensors:**  
Press and hold CHANNEL for 2 seconds. Each sensor's data is displayed for 3 seconds.



**To end auto-scan:**  
Press CHANNEL or MEM.

**To toggle between current, minimum and maximum records for the selected sensor:**  
Press MEM repeatedly.

**To clear the records:**  
Press and hold MEM for 2 seconds.

## TEMPERATURE TREND

Recent indoor / outdoor temperature trends are shown by the trend icon.

RISING	STEADY	FALLING
		

## ICE WARNING





If the channel 1 sensor falls between 3°C to -2°C (37°F to 28°F),  flashes to warn you that the temperature is approaching freezing.

**NOTE** The warning will automatically stop if the temperature goes outside the ice-warning range.

## HI / LO TEMPERATURE ALARM

An alarm can be set to sound if the sensor set to channel 1 records above or below a temperature of your choice.

### To set alarm ON / OFF:

- Press and hold TEMP HI / LO .
- Use ▲ or ▼ to select high / low temperature alarm. Press TEMP HI / LO  to confirm.
- Press ▲ or ▼ to set alarm ON / OFF and press TEMP HI / LO  to confirm.
- If alarm has been activated, use ▲ or ▼ to select the temperature.
- Press TEMP HI / LO  to confirm.

### To silence the hi / lo temperature alarm:

Press any key. The alarm resets automatically and will resound if the hi / lo temperature selected is recorded again.

## RESET

Press RESET to return the unit to the default settings.

## PRECAUTIONS

This product is engineered to give you years of satisfactory service if you handle it carefully. Here are a few precautions:

- Do not immerse the unit in water. If you spill liquid over it, dry it immediately with a soft, lint-free cloth.
- Do not clean the unit with abrasive or corrosive materials.
- Do not subject the unit to excessive force, shock, dust, temperature or humidity, which may result in malfunction, shorter electronic life span, damaged battery and distorted parts.
- Do not tamper with the unit's internal components. Doing so will invalidate the warranty on the unit and may cause unnecessary damage. The unit contains no user-serviceable parts.
- Only use fresh batteries as specified in the user's instructions. Do not mix new and old batteries.
- Do not use rechargeable batteries.
- Remove batteries when storing the product for a long time.
- Due to printing limitations, the displays shown in this manual may differ from the actual display.

- The contents of this manual may not be reproduced without the permission of the manufacturer.

**NOTE** The technical specifications for this product and the contents of the user manual are subject to change without notice.

## SPECIFICATIONS

TYPE	DESCRIPTION
<b>Main unit</b>	
Dimensions (L x W x D)	86 x 79 x 53 (mm) 3.4 x 3.1 x 2.1 (in)
Weight	80 g (2.82 lbs) without battery
<b>Remote unit</b>	
Dimensions (L x W x D)	92 x 60 x 20 mm (3.6 x 2.4 x 0.8 in)
Weight	62 g (2.22 ounces) without battery
<b>Temperature unit – °C / °F</b>	
Indoor range	-5°C to 50 °C (23°F to 122°F)
Outdoor range	-30°C to 60°C (-22°F to 140°F)
Resolution	0.1°C (0.2°F)
<b>Remote unit</b>	
RF frequency	433MHz
Range	Up to 30 meters (100 ft) with no obstructions
Transmission	Approx. every 40 seconds
Channel no.	1, 2 or 3
<b>Clock</b>	
Clock display	HH:MM
Hour format	12hr AM/PM or 24hr
Calendar	DD/MM or MM/DD
Weekday in 5 languages	(E, G, F, I, S)
Alarm	2-minutes
<b>Power</b>	
Main unit	2 x UM-4 (AAA) 1.5V batteries
Remote unit	2 x UM-4 (AAA) 1.5V batteries

**NOTE** We recommend that you use alkaline batteries with this product for longer usage and lithium batteries in temperatures below freezing.

## ABOUT OREGON SCIENTIFIC

Visit our website ([www.oregonscientific.com](http://www.oregonscientific.com)) to learn more about Oregon Scientific products such as digital cameras; MP3 players; children's electronic learning products and games; projection clocks; health and fitness gear; weather stations; and digital and conference phones. The website also includes contact information for our Customer Care department in case you need to reach us, as well as frequently asked questions and customer downloads.

We hope you will find all the information you need on our website, however if you're in the US and would like to contact the Oregon Scientific Customer Care department directly, please visit:  
[www2.oregonscientific.com/service/default.asp](http://www2.oregonscientific.com/service/default.asp)  
OR  
Call 1-800-853-8883.

For international inquiries, please visit:  
[www2.oregonscientific.com/about/international.asp](http://www2.oregonscientific.com/about/international.asp)

## FCC STATEMENT

This device complies with Part 15 of the FCC Rules. Operation is subject to the following two conditions: (1) This device may not cause harmful interference, and (2) This device must accept any interference received, including interference that may cause undesired operation.

**WARNING** Changes or modifications not expressly approved by the party responsible for compliance could void the user's authority to operate the equipment.

**NOTE** This equipment has been tested and found to comply with the limits for a Class B digital device, pursuant to Part 15 of the FCC Rules. These limits are designed to provide reasonable protection against harmful interference in a residential installation.

This equipment generates, uses and can radiate radio frequency energy and, if not installed and used in accordance with the instructions, may cause harmful interference to radio communications. However, there

is no guarantee that interference will not occur in a particular installation. If this equipment does cause harmful interference to radio or television reception, which can be determined by turning the equipment off and on, the user is encouraged to try to correct the interference by one or more of the following measures:

- Reorient or relocate the receiving antenna.
- Increase the separation between the equipment and receiver.
- Connect the equipment into an outlet on a circuit different from that to which the receiver is connected.
- Consult the dealer or an experienced radio / TV technician for help.

## DECLARATION OF CONFORMITY

The following information is not to be used as contact for support or sales. Please call our customer service number (listed on our website at [www.oregonscientific.com](http://www.oregonscientific.com)), or on the warranty card for this product) for all inquiries instead.

**We**  
Name: Oregon Scientific, Inc.  
Address: 19861 SW 95th Ave., Tualatin,  
Oregon 97062 USA  
Telephone No.: 1-800-853-8883

### declare that the product

Product No.: RAR681  
Product Name: Wireless Indoor / Outdoor  
Thermometer  
with Digital Clock  
Manufacturer: IDT Technology Limited  
Address: Block C, 9/F, Kaiser Estate,  
Phase 1, 41 Man Yue St.,  
Hung Hom, Kowloon,  
Hong Kong

is in conformity with Part 15 of the FCC Rules. Operation is subject to the following two conditions: 1) This device may not cause harmful interference. 2) This device must accept any interference received, including interference that may cause undesired operation.